COMPUTER SCIENCE

9608/13

Paper 1 Written Paper

October/November 2016

MARK SCHEME

Maximum Mark: 75

Published

This mark scheme is published as an aid to teachers and candidates, to indicate the requirements of the examination. It shows the basis on which Examiners were instructed to award marks. It does not indicate the details of the discussions that took place at an Examiners' meeting before marking began, which would have considered the acceptability of alternative answers.

Mark schemes should be read in conjunction with the question paper and the Principal Examiner Report for Teachers.

Cambridge will not enter into discussions about these mark schemes.

Cambridge is publishing the mark schemes for the October/November 2016 series for most Cambridge IGCSE[®], Cambridge International A and AS Level components and some Cambridge O Level components.

- 1 (a) **One mark** for each correct line.
Two lines from any box on left means no mark for that description.

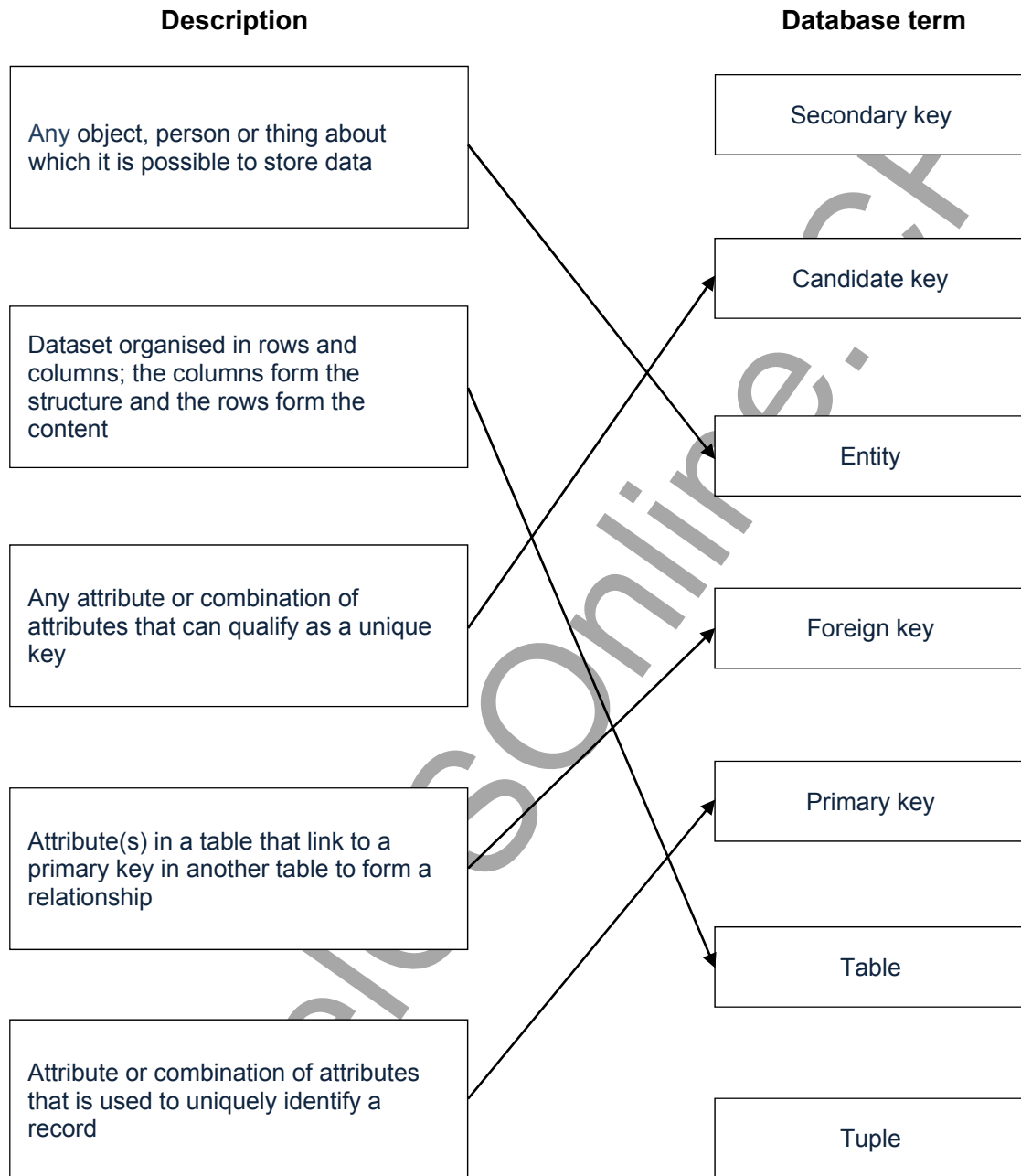

[5]

Page 3	Mark Scheme	Syllabus	Paper
	Cambridge International AS/A Level – October/November 2016	9608	13

(b) Any **three** from:

- Ensures related data in tables are consistent
- If one table has a foreign key (the 'foreign' table)...
- ... then it is not possible to add a record to that table / the 'foreign' table
- ... unless there is a corresponding record in the linked table with a corresponding primary key (the 'primary' table)
- Cascading delete
- If a record is deleted in the 'primary' table...
- all corresponding linked records in 'foreign' tables must also be deleted
- Cascading update
- If a record in the 'primary' table is modified...
- ... all linked records in foreign tables will also be modified

[3]

2 (a) Any **two** from:

- DRAM has to be refreshed / charged
// SRAM does not request a refresh
- DRAM uses a single transistor and capacitor
// SRAM uses more than one transistor to form a memory cell
// SRAM has more complex circuitry
- DRAM stores each bit as a charge
// SRAM each bit is stored using a flip-flop / latch
- DRAM uses higher power(because it requires more circuitry for refreshing)
// SRAM uses less power (no need to refresh)
- DRAM less expensive (to purchase / requires fewer transistors)
// SRAM is more expensive (to buy as it requires more transistors)
- DRAM has slower access time / speed (because it needs to be refreshed)
// SRAM has faster access times
- DRAM can have higher storage / bit / data density
// SRAM has lower storage / bit / data density
- DRAM used in main memory
// SRAM used in cache memory

[2]

Page 4	Mark Scheme	Syllabus	Paper
	Cambridge International AS/A Level – October/November 2016	9608	13

(b) (i) Any **two** from

- The hardware is unusable without an OS // hides complexity of hardware from user
- Acts as an interface / controls communications between user and hardware / hardware and software
- Provides software platform / environment on which other programs can be run [2]

(ii) Any **two** from:

- Process / task / resource management
- Main memory management
- Peripheral / hardware / device management
- File / secondary storage management
- Security management
- Provision of a software platform / environment on which other programs can be run – only if not given in part (b)(i)
- Interrupt handling
- Provision of a user interface run – only if not given in part (b)(i) [2]

(c) Any **two** from:

- A DLL file is a shared library file
- Code is saved separately from the main .EXE files
- Code is only loaded into main memory when required at run-time
- The DDL file can be made available to several applications (at the same time) [2]

Page 5	Mark Scheme	Syllabus	Paper
	Cambridge International AS/A Level – October/November 2016	9608	13

- 3 (a) (i) 0 0 1 0 1 1 1 0 [1]
- (ii) 1 1 0 1 0 0 1 0 [1]
- (iii) 2 E [1]
- (b) (i) **One mark** for the explanation and **one mark** for the example
- Each denary digit is written as a 4-bit binary number
 - Example: 46 = 0100 0110 [2]
- (ii) **One mark** for the explanation and **one mark** for the example
- Binary number is split up into groups of 4 bits (starting from the right)
// Each group of 4 bits is converted to a denary digit
 - Example: 0011 0111 = 37 [2]
- 4 (i) **Keyboard**
Any **two** from:
- Uses switches and circuits to translate keystrokes into signals the computer can understand
 - The key matrix is a grid of circuits / three layers of plastic underneath the keys
 - Each circuit is broken beneath the key / middle layer contains holes
 - When key pressed, a circuit is made / completed and a signal is sent
 - Processor compares location of signal from key matrix to a character map stored on ROM
 - A character code for each key press is saved in a keyboard buffer [2]
- (ii) **Optical Disc**
Any **two** from:
- Drive motor is used to spin the disc
 - Tracking mechanism moves the laser assembly
 - A lens focuses the laser onto the disc
 - Laser beam is shone onto disc to read / write
 - Surface of disc has a reflective metal layer / phase change metal alloy
 - Track(s) on the disc have sequence of pits and lands / amorphous and crystalline state
 - Reflected light in then encoded as a bit pattern [2]

Page 6	Mark Scheme	Syllabus	Paper
	Cambridge International AS/A Level – October/November 2016	9608	13

(iii) **Optical mouse**

Any **two** from:

- Laser / light shines onto a surface
- Through a (polished) ring at the base
- The light is reflected from the surface through the ring
- Sensor detects reflected light
- Capturing details / photograph of surface (under the ring)
- At about 1500 times per second
- As the mouse moves the sensor detects changes in the surface detail / photograph
- Which are translated into movement (change of x and y co-ordinates)
- The processor/software updates the position of the cursor on the screen

[2]

(iv) **Scanner**

Any **two** from:

- Main component of a scanner is a CCD array
- CCD is a collection of light sensitive diodes
- Laser beam / light is shone onto the source document/barcode
- The scanned image reaches the CCD through mirrors and lenses
- Sensors detect levels of reflected light
- Brighter light results in greater electrical charge
- Light intensity is converted (by software) to a digital value

[2]

5 (a) (i) One mark for each correct gate.

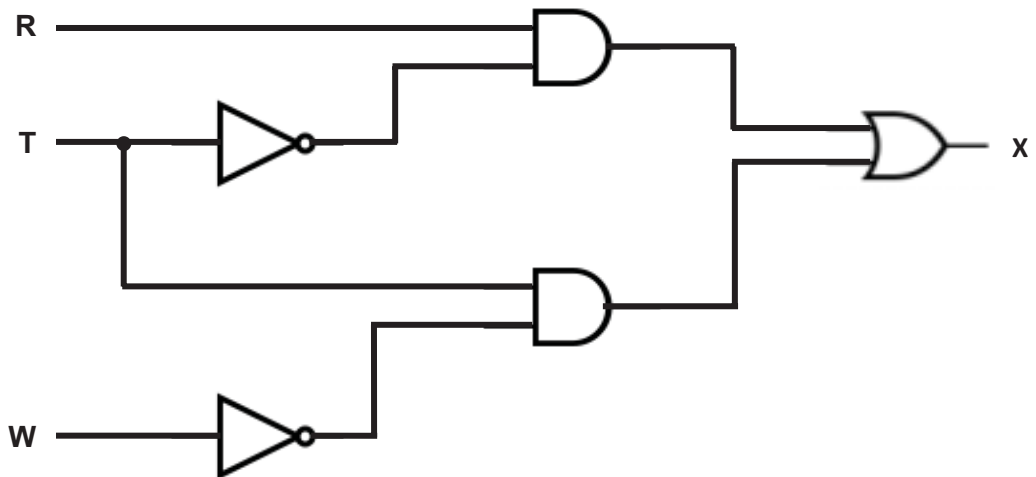

[5]

(ii) $(R\bar{T}) + (T\bar{W})$ // (R AND NOT T) OR (T AND NOT W)

[2]

(iii) One mark for each pair of lines as shaded.

INPUT			Working space	OUTPUT X
R	T	W		
0	0	0		0
0	0	1		0
0	1	0		1
0	1	1		0
1	0	0		1
1	0	1		1
1	1	0		1
1	1	1		0

[4]

Page 8	Mark Scheme	Syllabus	Paper
	Cambridge International AS/A Level – October/November 2016	9608	13

6 Any **four** from:

- User needs high-speed broadband (connection)
- Data is streamed to a buffer (in the computer)
- Buffering stops video pausing as bits streamed
- As buffer is emptied, it fills up again so that viewing is continuous
- Actual playback is (a few seconds) behind the time the data is received by computer [4]

7 (a) **One mark** for the name and **one mark** for the explanation for **three** utility programs

- Disk formatter
- Prepares a hard disk to allow data to be stored on it
- Virus checker
- Checks for viruses and then quarantines removes any virus found
- File compression
- Reduces file size by removing redundant details (lossy / lossless)
- Backup software
- Makes copy of files on another medium in case of corruption / loss of data
- Firewall
- Prevents unauthorised access to computer system from external sources [6]

(b) **Four** from:

- Bitmap is made up of pixels
// Vector graphic store a set of instructions about how to draw the shape
- Bitmap files are usually bigger than vector graphics files // Take up more memory space
- Enlarging a bitmap can mean the image is pixelated
// vector graphic can be enlarged without the image becoming pixelated
- Bitmap images can be compressed (with significant reduction in file size)
// Vector graphic images do not compress well
- Bitmaps are suitable for photographs / scanned images
// Vector graphics are suitable for more geometric shapes
- Bitmap graphics use less processing power than vector graphics
- Individual elements of a bitmap cannot be grouped
// Individual elements of a vector graphic can be grouped
- Vector graphics need to be 'rasterised' in order to display or print [4]

- (c) (i) • Hackers can still access the data (and corrupt it, change it or delete it)
• Encryption simply makes data incomprehensible (without decryption key / algorithm) [2]

(ii) Any **two** from:

- This is an explanation of data verification (not validation)
- Data validation ensures that data is reasonable / sensible / within a given criteria
- Original data may have been entered correctly but is not reasonable (e.g. age of 210) [2]

- (iii) • A password does not prevent unauthorised access, it makes it more difficult
• Password can be guessed (if weak) // Password can be stolen // A relevant example of misappropriation of password [2]

8 (a) (i)

Accumulator:

1	0	0	1	0	1	1	1
---	---	---	---	---	---	---	---

[1]

(ii) **One mark** for answer and **two marks** for explanation

Accumulator:

1	1	0	0	0	0	1	0
---	---	---	---	---	---	---	---

- Index Register contains $1001 = 9$
- $800 + 9 = 809$ [3]

(b) (i) **ONE** mark for each correct row.

ACC	Memory address				OUTPUT
	800	801	802	803	
	40	50	0	90	
40					
90			90		
90			90		
					Z

[4]

(ii) 107

[1]

Page 10	Mark Scheme	Syllabus	Paper
	Cambridge International AS/A Level – October/November 2016	9608	13

(c) (i) Any **two** from:

- Only 128 / 256 characters can be represented
- Uses values 0 to 127 (or 255 if extended form) / one byte
- Many characters used in other languages cannot be represented
- In extended ASCII the characters from 128 to 255 may be coded differently in different systems

[2]

(ii) Any **two** from:

- Uses 16, 24 or 32 bits / two, three or four bytes
- Unicode is designed to be a superset of ASCII
- Designed so that most characters (in other languages) can be represented

[2]

AlevelCSOnline.CF